



ST 010 101 5705



- 160mm projection
- fixed spout
- rectangular spray pattern with 40 individual jets
- height of mixer 108 mm
- height up to aerator 94 mm
- hole diameter valve 32 mm
- hole diameter spout 35 mm
- rosette 60 x 47 mm
- 2x screw-in M 10 x 1 pressure hose, leak-tested
- max. flow 4 l/min
- lead-free
- This product can help a building meet the requirements of Green Building Rating Systems, e.g. LEED®, BREEAM®, DGNB

	Chrome	ST 010 101 5705-00
	Brushed Platinum	ST 010 101 5705-06
	Brushed Dark Platinum	ST 010 101 5705-99

Individual components of this set

You need the following components for this set

1x 13 714 705-00



1x 20 004 716-00









1x 20 004 715-00



ST 010 101 5705



- 160mm projection
- fixed spout
- rectangular spray pattern with 40 individual jets
- height of mixer 108 mm
- height up to aerator 94 mm
- hole diameter 35 mm
- 2x screw-in M 10 x 1 pressure hose, leak-tested
- 1/2" connection
- max. flow 4 l/min
- lead-free
- This product can help a building meet the requirements of Green Building Rating Systems, e.g. LEED®, BREEAM®, DGNB

	Chrome	13 714 705-00
	Brushed Platinum	13 714 705-06
	Dark Chrome	13 714 705-19
	Brushed Champagne (22kt Gold)	13 714 705-46
	Champagne (22kt Gold)	13 714 705-47
	Brushed Dark Platinum	13 714 705-99

ST 010 101 5705

mm [inches]

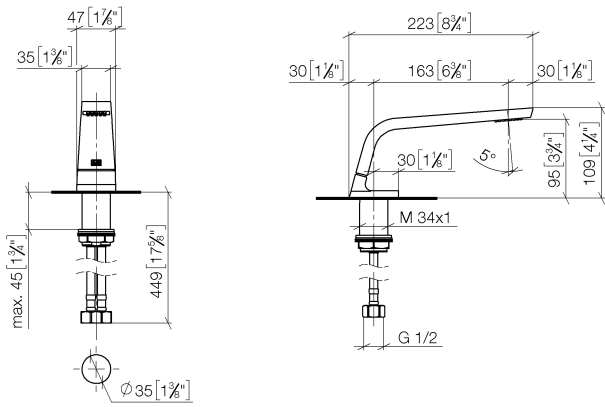

Flow rate chart

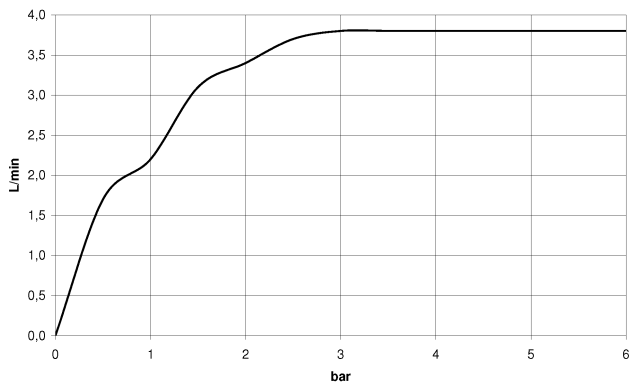

Codes & Standards

ASME
A112.18.1/CSA
B125.1

California Energy
Commission
(CEC)

NSF/ANSI 372

NSF/ANSI/CAN
61

Water Sense



Certificates

- GDV_0400279. LGA_28686. IAPMO_N-4976. IAPMO_8834 (1). IAPMO_4976 (6).
- WRAS_1512011. IAPMO_6397.

ST 010 101 5705

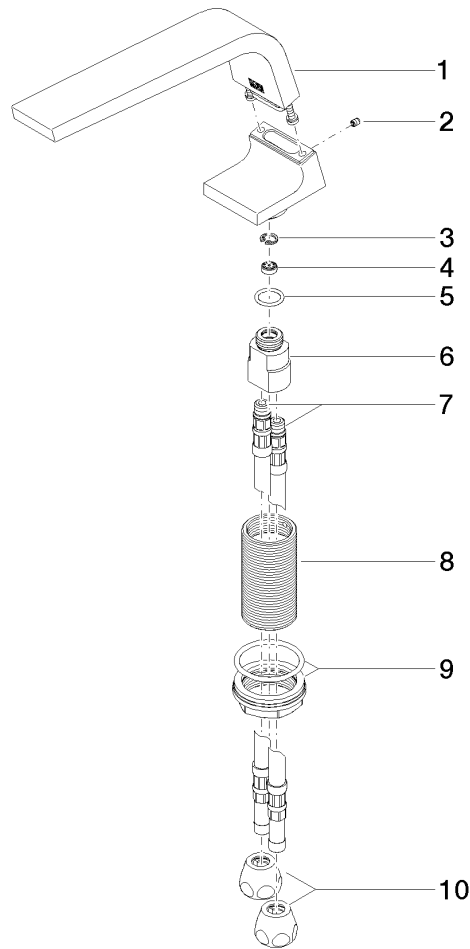

Spare parts list

No.	Item Number	Name	Quantity used	Delivery time
1	90 11 70 002 00-00	spout	1	10
2	09 31 11 044 90	pin	1	2
3	09 16 01 016 90	ring	1	2
4	09 23 01 034 90	flow reducer	1	2
5	09 14 10 130 90	seal	1	2
6	09 11 10 055 10 90	connection	1	2
7	04 30 04 016 00 90	hose	2	60
8	09 30 01 208 90	connection	1	2
9	04 23 10 044 06 90	fixing set	1	2
10	90 23 30 040 00-00	threaded connector	2	10

CL.1 Three-hole basin mixer without pop-up waste - Chrome







CL.1

ST 010 101 5705

- hole diameter 32 mm
- rosette 60 x 47 mm
- with cold marking



Fits: CL.1, CYO

	Chrome	20 004 716-00
	Brushed Platinum	20 004 716-06
	Brushed Durabross (23kt Gold)	20 004 716-28
	Brushed Champagne (22kt Gold)	20 004 716-46
	Champagne (22kt Gold)	20 004 716-47
	Brushed Dark Platinum	20 004 716-99



CL.1 Three-hole basin mixer without pop-up waste - Chrome

CL.1

ST 010 101 5705

ST 010 101 5705

mm [inches]

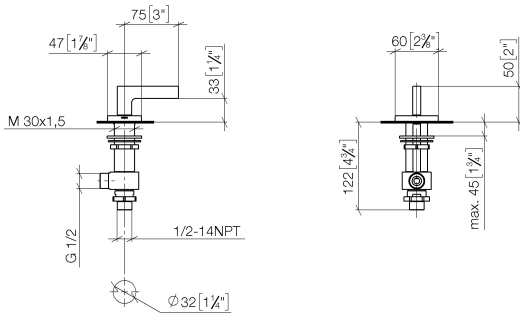

Flow rate chart

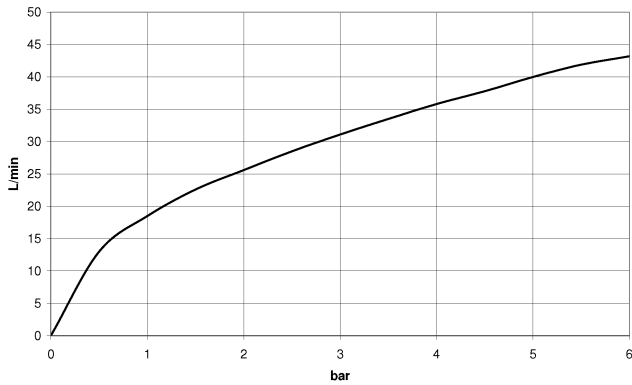

Codes & Standards

ADA	ASME A112.18.1/CSA B125.1	NSF/ANSI 372	NSF/ANSI/CAN 61
-----	---------------------------------	--------------	--------------------

Certificates

IAPMO_4976 (5). IAPMO_N-4976. LGA_28687. IAPMO_6397.

ST 010 101 5705

Parts for other finishes can be found here: Brushed Platinum

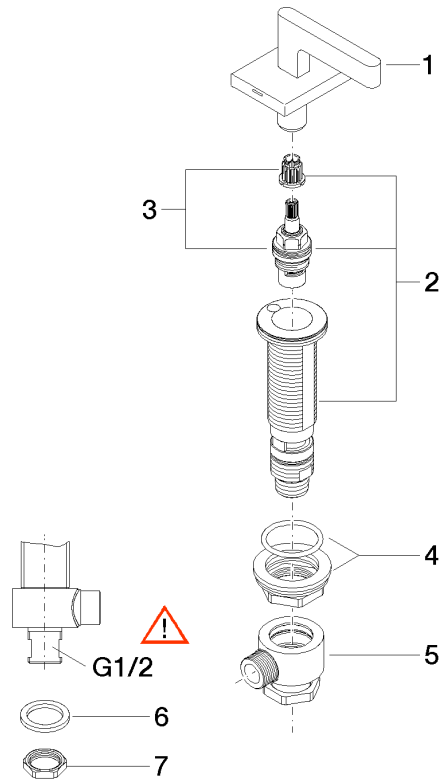

Spare parts list

No.	Item Number	Name	Quantity used	Delivery time
1	90 20 70 057 03-00	handle (cold)	1	10
2	04 17 11 058 52 90	side panel	1	2
3	90 90 03 152 00 90	top	1	2
4	04 23 10 032 78 90	fixing set	1	2
5	04 17 11 023 10 90	distributor	1	2
6	09 30 11 059 90	disc	1	2
7	09 23 10 012 90	nut	1	2

CL.1 Three-hole basin mixer without pop-up waste - Chrome







CL.1

ST 010 101 5705

- hole diameter 32 mm
- rosette 60 x 47 mm
- with hot marking



Fits: CL.1, CYO

	Chrome	20 004 715-00
	Brushed Platinum	20 004 715-06
	Brushed Durabrass (23kt Gold)	20 004 715-28
	Brushed Champagne (22kt Gold)	20 004 715-46
	Champagne (22kt Gold)	20 004 715-47
	Brushed Dark Platinum	20 004 715-99

ST 010 101 5705

mm [inches]

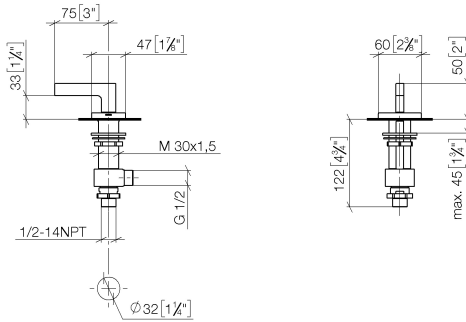

Flow rate chart

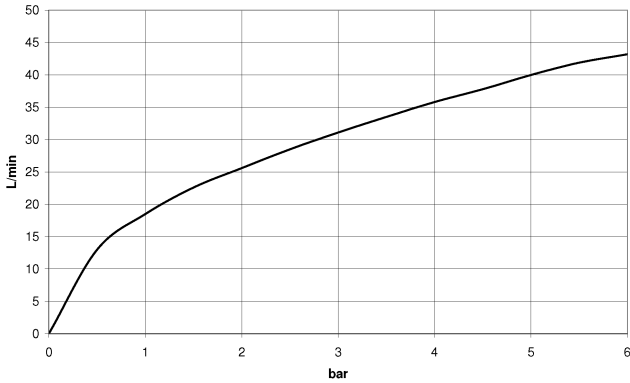

Codes & Standards

ADA	ASME A112.18.1/CSA B125.1	NSF/ANSI 372	NSF/ANSI/CAN 61
-----	---------------------------------	--------------	--------------------

Certificates

IAPMO_4976 (5). IAPMO_N-4976. LGA_28687. IAPMO_6397.

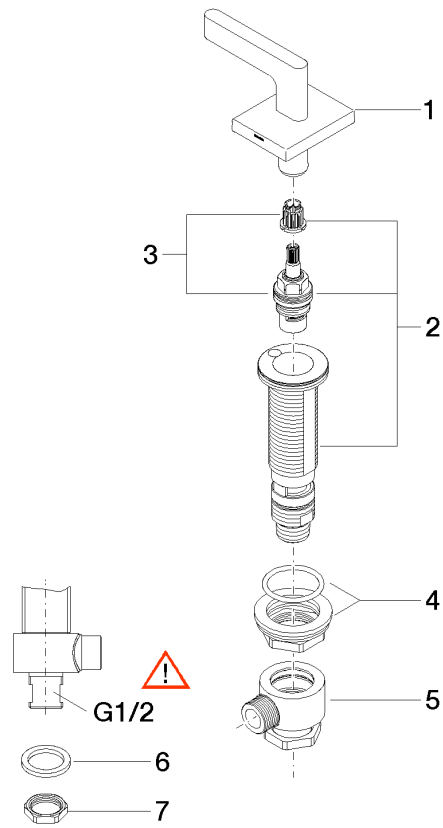

Spare parts list

No.	Item Number	Name	Quantity used	Delivery time
1	90 20 70 057 02-00	handle (hot)	1	10
2	04 17 11 058 53 90	side panel	1	2
3	90 90 03 153 00 90	top	1	2
4	04 23 10 032 78 90	fixing set	1	2
5	04 17 11 023 10 90	distributor	1	2
6	09 30 11 059 90	disc	1	2
7	09 23 10 012 90	nut	1	2